

TUROLIGHT®



2024 - 2025
Luminaires & Lamps
Luminaires et lampes



Better light,
better life.



Meilleure lumière,
meilleure vie.





LED Back-lit Panel Panneau à rétroéclairage DEL

RGD-BLP6

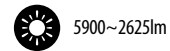

Selectable Wattage and Selectable Kelvin (CCT)
Puissances et températures Kelvin (TCP) sélectionnables

Optional for Emergency Battery BU or Microwave Motion Sensor.
Options offertes pour la batterie de secours UB ou le détecteur de mouvement à micro-ondes.

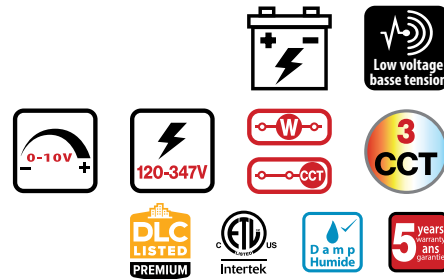

PRO-BLP3

New
Nouveau

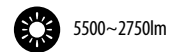

Selectable Wattage and Selectable Kelvin (CCT)
Puissances et températures Kelvin (TCP) sélectionnables

cULus listed / Homologué cULus

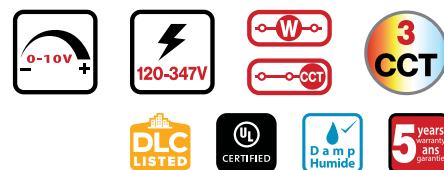

English



Scan for more details

Français



Balayer pour plus de détails

Model Modèle	Size Taille	Wattage Puissance	CCT / TCP	Voltage Tension	Dimmable Intensité variable	Factory Installed Installé à l'usine
RGD-BLP6	2'x2'	40-36-30W (5000-4500-3750lm) 30-25-21W (3750-3125-2625lm)	35-40-50K	120-347V	D (0-10V, 100%-1%)	Emergency BU / UB de secours Low voltage sensor Détecteur à basse tension
	1'x4'	36-30-25W (4500-3750-3125lm)				
	2'x4'	45-40-36W (5900-5000-4500lm)				

English



Scan for more details

Français



Balayer pour plus de détails

Model Modèle	Size Taille	Wattage Puissance	CCT / TCP	Voltage Tension	Dimmable Intensité variable
PRO-BLP3	2'x2'	40-30-25W (4400-3300-2750lm)	35-40-50K	120-347V	D (0-10V)
	1'x4'	40-30-25W (4400-3300-2750lm)			
	2'x4'	50-40-30W (5500-4400-3300lm)			



LED Centre Basket Luminaire DEL à panier central

RGD-CB3

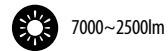

Slim design (2.24" depth) / Concept mince (profondeur de 2,24 po)
 Selectable Wattage and Selectable Kelvin (CCT)
 Puissances et températures Kelvin (TCP) sélectionnables
 Optional for Microwave Motion Sensor.
 Options offertes pour le détecteur de mouvement à micro-ondes.
 cULus listed / Homologué cULus



English



Scan for more details

Français



Balayer pour plus de détails



Model Modèle	Size Taille	Wattage Puissance	CCT / TCP	Voltage Tension	Dimmable Intensité variable	Factory Installed Installé à l'usine
RGD-CB3	2'x2'	35-30-25W (4375-3750-3125lm) 30-25-20W (3750-3125-2500lm)	35-40-50K	120-347V	D (0-10V)	Low voltage sensor Détecteur à basse tension
	1'x4'	30-25-20W (3750-3125-2500lm)				
	2'x4'	45-38-34W (5625-4750-4250lm) 56-52-46W (7000-6500-5750lm)				



LED Commercial Downlight Encastré commercial DEL

RGD-CDR



Selectable Wattage and Selectable Kelvin (CCT)
 Puissances et températures Kelvin (TCP) sélectionnables
 4", 6", 8", and 10" available / Offert en 4 po, 6 po, 8 po ou 10 po
 24" flexible conduit w / strain relief, 15" safety cable
 Conduit flexible de 24 po avec réducteur de tension, câble de sécurité de 15 po



English



Scan for more details

Français



Balayer pour plus de détails



Model Modèle	Size Taille	Wattage Puissance	CCT / TCP	Voltage Tension	Finish Fini	Dimmable Intensité variable
RGD-CDR	4"	12W (980lm)	30-35-40K	120-347V	White / Blanc	D (0-10V)
	6"	17-12-10W (1500-1000-850lm)				
	8"	20-17-14W (1850-1500-1200lm)				
	10"	40-35-30W (3700-3100-2700lm)				



LED Regressed Gimbal Encastré à cardan DEL en retrait

EDA-ECL, RGD-ECL



Air Tight, Adjustable Tilt
Étanche, inclinaison réglable

Available in brushed nickel, black and white
Disponible en nickel brossé, noir et blanc

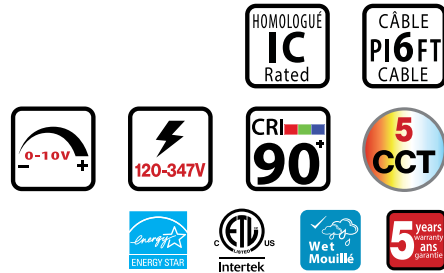

RGD-ECL/SQ **New Nouveau**



Air Tight, Adjustable Tilt
Étanche, inclinaison réglable

Available in black and white
Disponible en noir et blanc

Square Trim / Garniture carrée

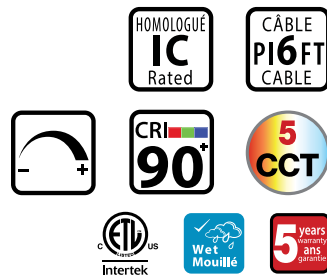

Scan for more details



Balayer pour plus de détails



New Nouveau

Model Modèle	Size Taille	Wattage Puissance	CCT / TCP	Voltage Tension	Trim Finish Fini de la garniture	Dimmable Intensité variable	Accessories Accessoires
EDA-ECL	4"	17W (1268lm)	27-30-35-40-50K	120-347V	White / Blanc Brushed Nickel / Nickel brossé Black / Noir	D (0-10V)	Reflector / Réflecteur, 24° Reflector / Réflecteur, 60° Down Light Frames Cadres pour encastrés
RGD-ECL	3.5"	12W (850lm)	27-30-35-40-50K	120V	White / Blanc Brushed Nickel / Nickel brossé Black / Noir	D (TRIAC 10-100%)	-
	4"	12W (850lm) 17W (1268lm)					Reflector / Réflecteur, 24° Reflector / Réflecteur, 60° Down Light Frames Cadres pour encastrés



Model Modèle	Size Taille	Wattage Puissance	CCT / TCP	Voltage Tension	Trim Finish Fini de la garniture	Dimmable Intensité variable	Accessories Accessoires
RGD-ECL/SQ	4"	12W (850lm) 17W (1268lm)	27-30-35-40-50K	120V	White / Blanc Black / Noir	D (TRIAC 10-100%)	Reflector / Réflecteur, 24° Reflector / Réflecteur, 60°



LED 3" Downlight Encastré DEL de 3 po

RGD-SMT



13~6W



1000~480lm

Brushed Nickel, White or Black trim
Garniture nickel brossé, blanc ou noir

Dim-to-Warm 2000K-3000K Accessoriesal

Gradation vers le chaud 2 000K-3 000K

Beam angle 38° / Angle de faisceau de 38°



English



Scan for more details

Français



Balayer pour plus de détails



With surface trim
Avec garniture en surface



With deep trim
Avec garniture profonde



Model Modèle	Size Taille	Wattage Puissance	CCT / TCP	Voltage Tension	Beam Angle Angle de faisceau	Dimmable Intensité variable
RGD-SMT	3"	6W (480lm) 8W (700lm) 12W (1000lm)	3000K	120V	38°	D (TRIAC 10-100%)
		13W (820lm)	Dim-to-Warm / Gradation vers le chaud (20-30K)			



LED 4" Gimbal Encastré à cardan DEL 4 po

RGD-CHY2



8W



700lm

Available in Brushed Nickel, Black, White and Gold
Disponible en nickel brossé, noir, blanc et or

Adjustable with 360° rotation, beam angle 40°

Rotation réglable sur 360°, angle de faisceau de 40°

Default with 4" trim, 3" trim sold separately

Garniture de 4 po par défaut, garniture de 3 po vendue séparément



English



Scan for more details

Français



Balayer pour plus de détails

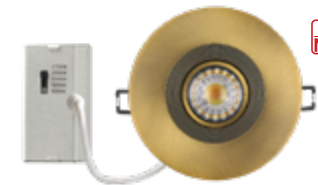

New
Nouveau

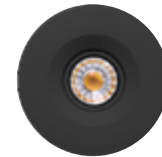
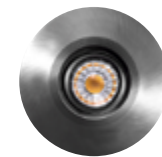

Model Modèle	Size Taille	Wattage Puissance	CCT / TCP	Voltage Tension	Trim Finish Fini de la garniture	Dimmable Intensité variable
RGD-CHY2	4"	8W (700lm)	27-30-35-40-50K	120V	White / Blanc Brushed Nickel / Nickel brossé Black / Noir Gold / Or	D (TRIAC dimmable / Gradation TRIAC)



LED Swivel Downlight Encastré DEL pivotant

RGD-JH, RGD-JH2 New
Nouveau



Available in Brushed Nickel, Black and White
Offert en nickel brossé, noir et blanc

Swivel, adjustable with 360° rotation
Pivotant, rotation réglable sur 360°

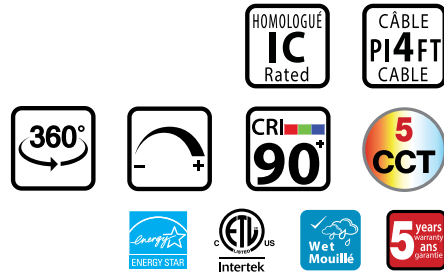

English



Scan for more details

Français



Balayer pour plus de détails



Model Modèle	Size Taille	Wattage Puissance	CCT / TCP	Voltage Tension	Finish Fini	Dimmable Intensité variable
RGD-JH2 New Nouveau	4"	9W (800lm)	27-30-35-40-50K	120V	White / Blanc Black / Noir	D (TRIAC dimmable / Gradation TRIAC)
RGD-JH	4"	9W (650lm)	27-30-35-40-50K	120V	Brushed Nickel / Nickel brossé	D (TRIAC dimmable / Gradation TRIAC)



LED Slim Panel Panneau DEL mince

SEL-SP/FR



2 Hr. Fire Rated
2 heures de résistance au feu
4", and 6" available / Offert en 4 po ou 6 po

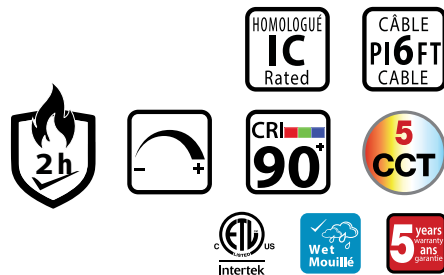

English



Scan for more details

Français



Balayer pour plus de détails



Model Modèle	Size Taille	Wattage Puissance	CCT / TCP	Voltage Tension	Finish Fini	Dimmable Intensité variable
SEL-SP/FR	4" 6"	12W (800lm) 15W (1100lm)	27-30-35-40-50K	120V	White / Blanc	D (TRIAC dimmable / Gradation TRIAC)



LED Slim Panel Panneau DEL mince

EDA-SP



Edge-lit slim profile suitable for low-depth installation
Profil mince à éclairage périphérique, adapté à une installation à faible profondeur

4", 6" and 8" available / Offert en 4 po, 6 po ou 8 po

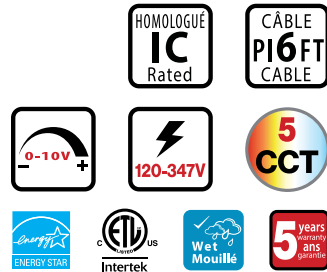

Scan for more details



Balayer pour plus de détails



Black trim ring
Anneau de garniture noir



Brush Nickel trim ring
Anneau de garniture nickel brossé

Model Modèle	Size Taille	Wattage Puissance	CCT / TCP	Voltage Tension	Finish Fini	Dimmable Intensité variable
EDA-SP	4"	8W (750lm)	27-30-35-40-50K	120-347V	White / Blanc	D (0-10V)
	6"	12W (1100lm)				
	8"	16W (1500lm)				



RGD-SP3



Edge-lit slim profile suitable for low-depth installation
Profil mince à éclairage périphérique, adapté à une installation à faible profondeur

4" and 6" available / Offert en 4 po ou 6 po

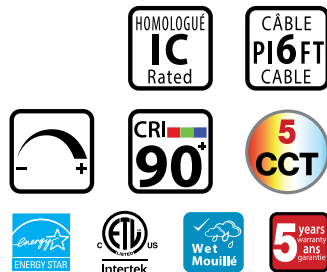

Scan for more details



Balayer pour plus de détails



Black trim ring
Anneau de garniture noir



Brush Nickel trim ring
Anneau de garniture nickel brossé

Model Modèle	Size Taille	Wattage Puissance	CCT / TCP	Voltage Tension	Finish Fini	Dimmable Intensité variable
RGD-SP3	4"	9W (700lm)	27-30-35-40-50K	120V	White / Blanc	D (TRIAC dimmable / Gradation TRIAC)
	6"	12W (930lm)				



LED Slim Panel Panneau DEL mince

PRO-SP6



8W



750lm

Edge-lit slim profile suitable for low-depth installation
Profil mince à éclairage périphérique, adapté à une installation à faible profondeur

6 pcs/pack & single pack options

Options de 6 un./boîte et emballage d'une unité



English



Scan for more details

Français



Balayer pour plus de détails



Black trim ring
Anneau de garniture noir



Brush Nickel trim ring
Anneau de garniture nickel brossé

Model Modèle	Size Taille	Wattage Puissance	CCT / TCP	Voltage Tension	Finish Fini	Dimmable Intensité variable
PRO-SP6	4"	8W (750lm)	27-30-35-40-50K	120V	White / Blanc	D (TRIAC dimmable / Gradation TRIAC)



LED Retrofit Slim Panel Panneau DEL mince pour rénovation

RGD-RSP

New
Nouveau



9W



700lm

Edge-lit slim profile suitable for low-depth installation
Profil mince à éclairage périphérique, adapté à une installation à faible profondeur

All-In-One design / Conception tout-en-un

2 Bezel color options (Black and White)

2 options de couleur de collerette (noir et blanc)

Mount easily into 4" octagonal junction box or 4" recessed can.

Se monte facilement dans une boîte de jonction octogonale de 4 pouces ou des boîtiers encastrés de 4 pouces.



Magnet / Aimant

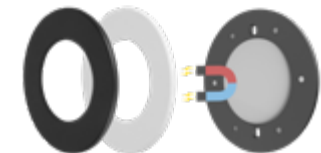

Model Modèle	Size Taille	Wattage Puissance	CCT / TCP	Voltage Tension	Finish Fini	Dimmable Intensité variable
RGD-RSP	4"	9W (700lm)	27-30-35-40-50K	120V	White / Blanc	D (TRIAC dimmable / Gradation TRIAC)



Pot Light Multi-Cutout Plate Plaque pour plusieurs ouvertures d'encastré

PL-AMP-MULTI-VPLUS
PL-AMP-MULTI-V

One plate for all Turolight 4" family recessed LED fixtures.
Une plaque pour tous les luminaires encastrés DEL de la gamme 4 po de Turolight.

PL-AMP6

One plate for all Turolight 6" family recessed LED fixtures.
Une plaque pour tous les luminaires encastrés DEL de la gamme 6 po de Turolight.

PL-AMP-MULTI-VPLUS

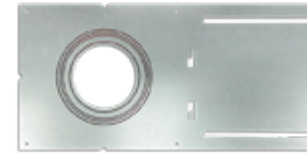

PL-AMP-MULTI-V

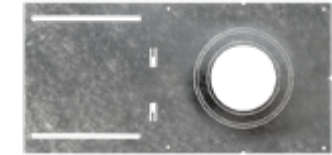

PL-AMP6



Model Modèle	Size Taille	Turolight recessed LED fixtures Luminaires encastrés DEL de Turolight
PL-AMP-MULTI-VPLUS	4"	EDA-ECL/4, RGD-ECL/4, EDA-ECL/3.5, RGD-SMT/53, RGD-SMT/59, RGD-CHY2, RGD-JH2, RGD-JH, SEL-SP/FR/4, EDA-SP/4, RGD-SP3/4, PRO-SP6/4, RGD-CDR/4
PL-AMP-MULTI-V	4"	EDA-ECL/4, RGD-ECL/4, RGD-SMT/53, RGD-SMT/59, RGD-CHY2, RGD-JH2, RGD-JH, SEL-SP/FR/4, EDA-SP/4, RGD-SP3/4, PRO-SP6/4, RGD-CDR/4
PL-AMP6	6"	EDA-SP/6, RGD-SP3/6, RGD-CDR/6



LED Surface Discus Discus DEL en surface

EDA-HS **New**
Nouveau

40~10W

3600~900lm

Flush Mtg. to J-Box is default, optional Mtg., Semi-Flush, Pendant, AC cable

Montage affleurant sur boîte de jonction par défaut, options de montage semi-affleurant et en suspension, câble CA

English



Scan for more details



Français



Balayer pour plus de détails



Model Modèle	Size Taille	Wattage Puissance	CCT / TCP	Voltage Tension	Finish Fini	Dimmable Intensité variable	Accessories Accessoires
EDA-HS	8"	10W (900lm)	30-40-50K	120-277V	White Blanc	D (0-10V)	Surface Semi-Flush Mtg. Kit.
	11"	15W (1350lm)					Trousse de montage affleurant en surface
	16"	25W (2250lm)					Pendant Mount Kit.
	24"	40W (3600lm)					Trousse de montage en suspension





LED Surface Discus Discus DEL en surface

RGD-HS, RGD-HS2 New
Nouveau



RGD-HS

Mounts directly to J-box or retrofit 4", 5", 6" downlight
S'installe directement sur la boîte de jonction ou pour conversion
d'encastres de 4 po, 5 po et 6 po

Interchangeable trim ring for Matte Black or Satin Nickel finish
Anneau de garniture noir mat ou nickel satiné interchangeable

RGD-HS2

Mounts directly to J-box
S'installe directement sur la boîte de jonction



RGD-HS2

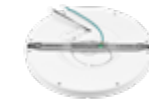

RGD-HS



Matte Black metal trim / Garniture de métal noir mat



Satin Nickel metal trim / Garniture de métal nickel satiné

On selectable CCT units only (RGD-HS)
Sur les unités à TCP sélectionnables uniquement (RGD-HS)

Model Modèle	Size Taille	Wattage Puissance	CCT / TCP	Voltage Tension	Finish Fini	Dimmable Intensité variable	Accessories Accessoires
RGD-HS2 	5"	10W (800lm)	27-30-35-40-50K	120V	White Blanc	D (TRIAC 10-100%)	-
	7"	12W (1100lm)					
	9"	18W (1400lm)					
	11"	26W (2000lm)					
RGD-HS	4"	6W (420lm)	3000K 30-40-50K	120V	White Blanc	D (TRIAC 10-100%)	Tension Clip Kit. / Trousse d'agrafe à ressort Matte Black metal trim / Garniture de métal noir mat Satin Nickel metal trim / Garniture de métal nickel satiné
	6"	12W (840lm)					
	8"	18W (1260lm)					
	11"	24W (1920lm)					
	16"	30W (2400lm)					
	24"	48W (3800lm)					



LED Flush Mount Plafonnier DEL à montage affleurant

RGD-FM /2R

2 Ring, Selectable Wattage and Selectable Kelvin (CCT)
2 anneaux, puissances et températures Kelvin (TCP) sélectionnables

RGD-FM /1R

1 Ring, 5 CCT Colour selectable / 1 anneau, sélection de 5 TCP

RGD-FM /SLIM /PC

Slim polycarbonate, 5 CCT Colour selectable
Polycarbonate mince, sélection de 5 TCP

RGD-FM /PC

Polycarbonate material / Matériau polycarbonate
Selectable Wattage and Selectable Kelvin (CCT)
Puissances et températures Kelvin (TCP) sélectionnables



English



Scan for more details



RGD-FM /2R



RGD-FM /PC

Français



Balayer pour plus de détails



RGD-FM /1R



RGD-FM /SLIM /PC

Model Modèle	Size Taille	Wattage Puissance	CCT / TCP	Voltage Tension	Dimmable Intensité variable	Body Boîtier
RGD-FM/2R	14"	22-18-15W (1540-1260-1000lm)	30-40-50K	120V	D (Dimmable /Gradation)	2 Ring / 2 anneaux
	16"	24-21-18W (1680-1470-1260lm)				
	18"	32-28-24W (2240-1960-1680lm)				
RGD-FM/S/2R	14"	21W (1470lm)	4000K, 3000K		(x), Motion Sensor installed Détecteur de mouvement installé	
RGD-FM/1R	15"	24W (1800lm)	27-30-35-40-50K	120V	D (Dimmable /Gradation)	1 Ring / 1 anneau
RGD-FM/SLIM/PC	14"	24W (1800lm)	27-30-35-40-50K	120V	D (Dimmable /Gradation)	Polycarbonate (Slim / Mince)
RGD-FM/PC	13"	22-18-15W (1600-1300-1090lm)	30-40-50K	120V	D (Dimmable /Gradation)	Polycarbonate
	19"	32-28-24W (2240-1960-1680lm)				



LED Vanity / Wall Sconce Light Applique murale DEL pour meuble-lavabo

RGD-VN/WS **New Nouveau**

24W 1700lm

2 shapes offering: squared and rounded
Offre de 2 formes : carrée et arrondie

2 finishing colours: black & brush nickel
2 couleurs de finis : noir et nickel brossé



Model Modèle	Length Longueur	Wattage Puissance	CCT / TCP	Voltage Tension	Dimmable Intensité variable	Body Shape Forme du boîtier	Finish Fini
RGD-VN/WS	2'	24W (1700lm)	27-30-35-40-50K	120V	D (Dimmable / Gradation)	Squared / Carrée Rounded / Arrondie	Brushed Nickel / Nickel brossé Black / Noir



LED Vanity & Wall Sconce Light Luminaire et applique murale DEL pour meuble-lavabo

RGD-VN, RGD-WS

15~14W 1450~1100lm

Aluminium frame / Cadre d'aluminium
PMMA lens / Lentille de PMMA



RGD-WS, RGD-WS2

RGD-VN

Model Modèle	Wattage Puissance	CCT / TCP	Voltage Tension	Dimmable Intensité variable	Type
RGD-VN (2')	14W (1450lm)	3000K 4000K	120V	D (TRIAC 10-100%)	2 Ring / 2 anneaux
RGD-WS	15W (1100lm)	3000K 4000K	120V	D (TRIAC 10-100%)	2 Ring / 2 anneaux



LED Closet Light Luminaire DEL de placard

RGD-CL2



15~10W



1000~600lm

Motion Sensor installed
Détecteur de mouvement installé

4", 6" available / Offert en 4 po, 6 po

Beam angle 120° / Angle de faisceau 120°

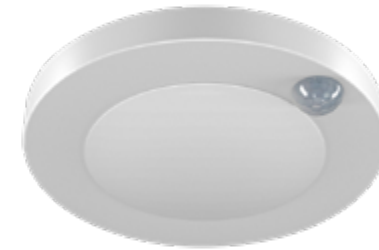

Model Modèle	Size Taille	Wattage Puissance	CCT / TCP	Voltage Tension	Sensor Détecteur	Finish Fini
RGD-CL2	4" 6"	10W (600lm) 15W (1000lm)	27-30-35-40-50K	120V	PIR / infrarouge passif (Motion Sensor / Détecteur de mouvement)	White / Blanc

Cylinder Light Fixture Luminaire cylindrique

SEL-CYL **New
Nouveau**

Indoor and outdoor use
Usage intérieur et extérieur

Light bulb not included
Ampoule non incluse

Light Direction: down
Direction de l'éclairage : vers le bas

Mounting: wall mount only
Montage : montage mural seulement

Recommended Bulb Shape: PAR20
Forme de l'ampoule recommandée : PAR20



Model Modèle	Mounting Montage	Bulb Base Culot de l'ampoule	Voltage Tension	Max. Wattage Puiss. maximale	Finish Fini
SEL-CYL/BK/WS/DL	Wall / Mural	E26	120V	60W	Black / Noir



Dome Light Fixture Luminaire hémisphérique

SEL-DOME **New**
Nouveau

Indoor use only / Usage intérieur seulement
 Light bulb not included
 Ampoule non incluse
 Mounting: ceiling / Pendant mount only
 Montage : montage au plafond/suspendu seulement
 Recommended Bulb Shape: A19
 Forme de l'ampoule recommandée : A19



Model Modèle	Mounting Montage	Bulb Base Culot de l'ampoule	Voltage Tension	Max. Wattage Puiss. maximale	Finish Fini
SEL-DOME/BK/PEND	Ceiling / Plafond	E26	120V	60W	Matt Black finish (Shiny White inside) Fini noir mat (blanc lustré à l'intérieur)



LED Linear Pendant Luminaire Luminaire linéaire DEL suspendu

ZNTH60 **New**
Nouveau

80~25W 10400~3250lm

Pendant Mounting
 Montage en suspension
 4', 8' available / Offert en 4 pi, 8 pi
 2 finishing colours: black & white
 2 couleurs de finis : noir et blanc

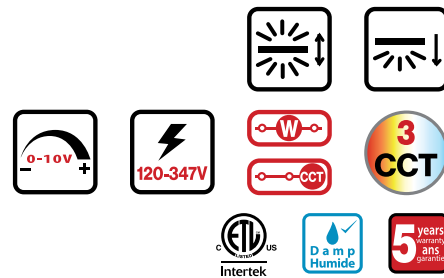
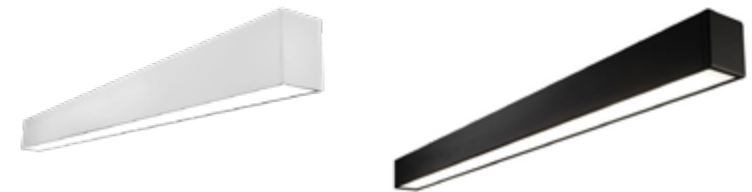

Model Modèle	Mounting Montage	Function Fonction	Length Longueur	Wattage Puissance	CCT / TCP	Voltage Tension	Finish Fini
ZNTH60-PD	Pendant Mtd. Montage en suspension	Direct Éclairage direct	4' 8'	40-33-25W (5200-4290-3250lm) 80-66-50W (10400-8580-6500lm)	30-35-40K	120-347V	White / Blanc Black / Noir
ZNTH60-PDI	Pendant Mtd. Montage en suspension	Direct/ Indirect Éclairage direct/indirect	4' 8'	40-33-25W (5200-4290-3250lm) 33-28-22W (4290-3640-2860lm) 80-66-50W (10400-8580-6500lm) 66-56-44W (8580-7280-5720lm)	30-35-40K ↓ ↑	120-347V	White / Blanc Black / Noir
ZNTH60-PRO/PD	Pendant Mtd. Montage en suspension	Direct Éclairage direct	4'	40-33-25W (5200-4290-3250lm)	30-35-40K	120-347V	White / Blanc



LED Wrap Around Luminaire enveloppant DEL

DL-WA2, WA3, WA5T2 **New Nouveau**



42~20W



5502~2600lm

Wall or ceiling mounted / Montage mural ou au plafond

PMMA lens / Lentille de PMMA

Shallow profile, excellent for low ceilings applications

Profil peu profond, idéal pour les applications à plafonds bas



English



Scan for more details

Français



Balayer pour plus de détails



Model Modèle	Size Taille	Wattage Puissance	CCT / TCP	Voltage Tension	Dimmable Intensité variable	Option
DL-WA5T2	2'	20W (2600lm)	30-35-40-50K	120-347V	D (0-10V)	Low voltage sensor / Détecteur à basse tension Emergency battery / Batterie de secours
	4'	40W (5200lm)				
DL-WA3	4'	42W (5502lm)	3500K, 4000K	120-347V	D (0-10V)	-
DL-WA2	2'	25W (3275lm)	4000K	120-277V	D (0-10V)	Microwave sensor / Détecteur à micro-ondes Emergency battery / Batterie de secours
	4'	40W (5240lm) 40-35-30W (5200-4550-3900lm)	3500K, 4000K 35-40-50K			

LED Shelf & Cabinet Lights Luminaire pour étagères et armoires DEL

DL-SCL **New Nouveau**



16~3W



1680~315lm

Multiple length options from 1' to 4' linear luminaires

Options de plusieurs longueurs de luminaires linéaires de 1 pi à 4 pi

Luminaire may be joined together for linkable runs c/w 11" jumper cable if desired and end cap.

Les luminaires peuvent être raccordés ensemble pour créer des enfilades avec câble de liaison de 11 po et embout.

Optional mounting hardware supplied allows for surface or side mount applications, c/w 61" white power cable with molded 2 prong plug.

Pièces de fixation pour montage en option incluses permettant une installation en surface ou sur le côté, avec câble d'alimentation blanc de 61 po et fiche moulée à 2 lames.



English



Scan for more details

Français



Balayer pour plus de détails



Model Modèle	Size Taille	Wattage Puissance	CCT / TCP	Voltage Tension	Finish Fini
DL-SCL	1'	5-3W (525-315lm)	30-40-50K	120V	White / Blanc
	2'	7-4.2W (735-440lm)			
	3'	9-5.5W (945-578lm)			
	4'	12-7.5W (1260-788lm) 16-9.5W (1680-998lm)			



LED Premium Commercial Strip Réglette commerciale DEL de première qualité

SEL-PS



80~30W



10400~3900lm

White post painted CRCA Steel Housing in 4' and 8'
Boîtier en acier CRCA (laminé à froid proche du recuit) peint blanc après montage offert en longueurs de 4 pi ou 8 pi

Suitable for Surface, or suspended chain mounting. J-BOX split cover plate (included)

Convient au montage en surface ou suspendu par chaîne. Plaque de couvercle de boîte de jonction (incluse)



Scan for more details



Balayer pour plus de détails



Model Modèle	Size Taille	Wattage Puissance	CCT / TCP	Voltage Tension	Dimmable Intensité variable	Option
SEL-PS	4' 8'	40-35-30W (5200-4550-3900lm) 80-70-60W (10400-9150-7800lm)	35-40-50K	120-347V	D (0-10V)	Auxiliary Driver / Pilote auxiliaire Low voltage sensor / Détecteur à basse tension



LED Eco-Commercial Strip Réglette DEL Eco-Commercial

PRO-EC2 **New**
Nouveau



80~30W



10400~4260lm

4' and 8' length selection

Sélection de longueurs de 4 pi et 8 pi

White metal finish, polymer diffusing lens

Fini de métal blanc, lentille de polymère diffusante

Wall and surface mounting

Montage mural et en surface

cULus listed / Homologué cULus



Scan for more details



Balayer pour plus de détails



Model Modèle	Size Taille	Wattage Puissance	CCT / TCP	Voltage Tension	Dimmable Intensité variable	Option
PRO-EC2	4' 8'	40-35-30W (5420-4970-4260lm) 80-70-60W (10400-9150-7800lm)	35-40-50K	120-347V	D (0-10V)	Emergency BU / UB de secours Low voltage sensor / Détecteur à basse tension



LED Eco-Commercial Strip Réglette DEL Eco-Commercial

DL-EC2



90~16W



11700~2080lm

White post painted steel housing in 2', 4' and 8' lengths
Boîtier en acier peint blanc après montage offert en longueurs de 2 pi, 4 pi ou 8 pi

cULus listed / Homologué cULus

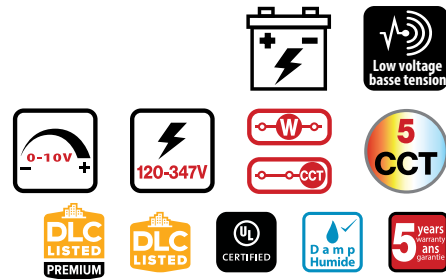

English



Scan for more details

Français



Balayer pour plus de détails



Model Modèle	Size Taille	Wattage Puissance	CCT / TCP	Voltage Tension	Dimmable Intensité variable	Option
DL-EC2	2'	20-18-16W (2600-2340-2080lm)	30-35-40-50-65K	120-347V	D (0-10V)	Low voltage sensor / Détecteur à basse tension Emergency battery / Batterie de secours
	3'	25-21-17W (3250-2730-2210lm)				
	4'	56W (7280lm) 30-25-18W (3900-3250-2340lm) 45-38-34W (6075-4940-4420lm)				
	8'	90-75-65W (11700-9750-8450lm)				

DL-EC



90~20W



12150~2620lm

White post painted steel housing in 2', 3', 4' and 8' lengths
Boîtier en acier peint blanc après montage offert en longueurs de 2 pi, 3 pi, 4 pi ou 8 pi

cULus listed / Homologué cULus

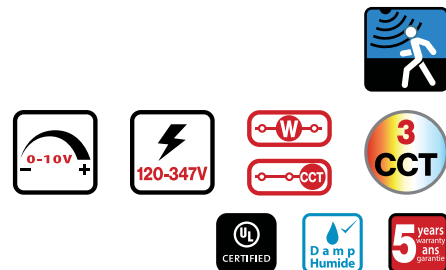

English

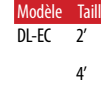

Scan for more details

Français

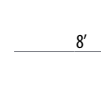

Balayer pour plus de détails



Model Modèle	Size Taille	Wattage Puissance	CCT / TCP	Voltage Tension	Dimmable Intensité variable	Option
DL-EC	2'	20W (2620lm)	35-40-50K	120-347V	D (0-10V)	Motion Sensor / Détecteur de mouvement
	4'	56W (7448lm) 45-38-34W (6075-4940-4420lm)				
	8'	90-75-65W (12150-9750-8450lm)				



LED Vapor Tight Luminaire DEL étanche à la vapeur

DL-VTHO

200~140W

34000~23800lm

High lumen output / Flux lumineux élevé

Linear 4', IP66 rated luminaire

Luminaire linéaire de 4 pi à indice de protection IP66

NEMA 4X



English



Scan for more details

Français



Balayer pour plus de détails



Model Modèle	Size Taille	Wattage Puissance	CCT / TCP	Voltage Tension	Dimmable Intensité variable	Option
DL-VTHO	4'	200-170-140W (34000-28900-23800lm)	35-40-50K	120-347V	D (0-10V)	Low voltage sensor Détecteur à basse tension



DL-VT2, DL-VT3

New
Nouveau

95~14W

13300~2000lm

Linear 2', 4' or 8' IP66 rated luminaire

Luminaire linéaire de 2 pi, 4 pi ou 8 pi à indice de protection IP66

NEMA 4X



English



Scan for more details

Français



Balayer pour plus de détails



Model Modèle	Size Taille	Wattage Puissance	CCT / TCP	Voltage Tension	Dimmable Intensité variable	Accessories Accessoires
DL-VT3	4'	36-31-24W (4500-4050-3285lm) 48-41-33W (6750-5310-4365lm)	35-40-50K	120-347V	D (0-10V)	Low voltage sensor Détecteur à basse tension
New Nouveau						
DL-VT2	2'	20-17-14W (2800-2400-2000lm)	35-40-50K	120-347V	D (0-10V)	Low voltage sensor Détecteur à basse tension
	4'	36-31-26W (5000-4500-3900lm) 48-41-34W (7500-6400-5600lm)				
New Nouveau	5'	65W-54W-40W (10010-8320-6160lm)				
	8'	75-65-55W (10500-9400-8100lm) 95-83-67W (13300-12000-10100lm)				



LED Circular HighBay Luminaire DEL circulaire pour très grande hauteur

SSL-CHB2, SEL-RHB

300~90W 51000~12150lm

Default hook mounting, yoke mount accessory ordered separately
Montage sur crochet par défaut, montage sur étrier accessoire à commander séparément

10' Power cord / Cordon d'alimentation de 10 pi

NEMA 4X



SSL-CHB2



SEL-RHB



Microwave sensor & remote control
Détecteur à micro-ondes et télécommande



90 Degree 16" aluminium hood
Toit d'aluminium 16 po 90 degrés



90 Degree 16" polycarbonate hood
Toit de polycarbonate 16 po 90 degrés

Model Modèle	Wattage Puissance	CCT TCP	Voltage Tension	Installation	Dimmable Intensité variable	Accessories Accessoires
SSL-CHB2	150-120-90W (20250-16200-12150lm) 240-200-180W (32400-27000-20250lm)	40-50K	120-347V	Hook / Crochet	D (0-10V)	Low voltage sensor Déecteur à basse tension
SEL-RHB	300-270-240W (51000-45900-40800lm)	40-50K	120-347V	Hook / Crochet	D (0-10V)	Low voltage sensor Déecteur à basse tension



LED Linear High Bay Luminaire DEL linéaire pour très grande hauteur

SSL-LHB5

400~78W 60000~11700lm

Equipped with 12V receptacle, for microwave motion sensor
Accessories

Muni d'un réceptacle de 12V, pour le détecteur à mouvement à micro-ondes accessoire

10' Power cord / Cordon d'alimentation de 10 pi

cULus listed / Homologué cULus



English



Scan for more details

Français



Balayer pour plus de détails



12V Microwave sensor
Déecteur à micro-ondes de 12V

Model Modèle	Wattage Puissance	CCT TCP	Voltage Tension	Mounting Montage	Dimmable Intensité variable	Accessories Accessoires
SSL-LHB5	78W (11700lm) 155-130-105W (23250-19500-15750lm) 270-230-200W (40500-34500-30000lm) 400-360-320W (60000-54000-48000lm)	40-50K	120-347V	Aircraft cable 10' set Ensemble de câble d'aéronef de 10 pi	D (0-10V)	Low voltage sensor Déecteur à basse tension



LED Sports Light Luminaire DEL pour les sports

SSL-SL3 **New**
Nouveau

1000~300W 156000~45000lm

Delivers volumetric lighting and reducing glare.
Procure un éclairage volumétrique et un éblouissement réduit.
Beam Angle / Angle de faisceau (15°/25°/40°/60°/80°)
cULus listed / Homologué cULus

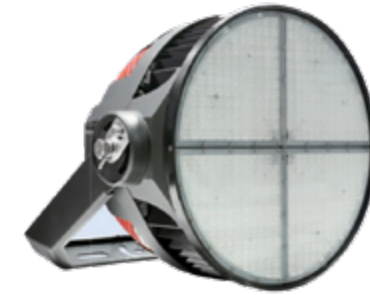
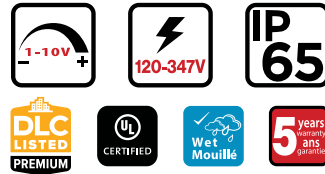

Model Modèle	Wattage Puissance	CCT TCP	Voltage Tension	Dimmable Intensité variable	Finish Fini
SSL-SL3	600-500-400-300W (90000-75000-60000-45000lm) 1000-900-800-700W (156000-135000-120000-105000lm)	5000K	120-347V	D (1-10V)	Black / Noir



LED Post Top Luminaire DEL en bout de fût

EDA-PT
 150~40W 19500~5200lm

Preinstalled Receptacle and Shorting Cap for ease of Photocell installation
Réceptacle et fiche de mise en court-circuit préinstallés pour faciliter l'installation de la cellule photoélectrique
Double Arm : Type V Optics / Bras double: optique de type V
Single Arm : Type V Optic is default, Type 2 and Type 3 optics ordered separately for EDA-PT/SN variant only
Bras simple: optique de type V par défaut, optique de type 2 et de type 3 commandées séparément pour la variante EDA-PT/SN uniquement
cULus listed / Homologué cULus

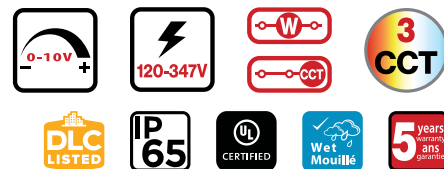

Model Modèle	Shape Forme	Wattage Puissance	CCT / TCP	Voltage Tension	Finish Fini	Dimmable Intensité variable	Accessories Accessoires
EDA-PT/DB	Double Arm Bras double	75-60-40W (9750-7800-5200lm) 150-125-100W (19500-16250-13000lm)	30-40-50K	120-347V	Black Noir	D (0-10V)	-
EDA-PT/SN	Single Arm Bras simple	100-70-40W (13000-9100-5200lm)	30-40-50K	120-347V	Black Noir	D (0-10V)	Type 2 lens / lentille de type 2 Type 3 lens / lentille de type 3



LED Bollard Bollard DEL

EDA-BOL

30~18W 2400~1440lm

3 Head shapes: Opal PC lensed, No lens and Clear PC lensed
3 formes de têtes : avec lentille de PC opale, sans lentille et lentille de PC claire

Sold as 2 piece set: Combo Fixture (Bollard Head + Body Cylinder) and Anchor Bolt Set

Vendu dans une trousse de 2 unités: combinaison de luminaire (tête de bollard + cylindre de boîtier) et ensemble de boulon d'ancrage

cULus listed / Homologué cULus



Model Modèle	Fixture Detail Description du luminaire	Wattage Puissance	CCT / TCP	Voltage Tension	Finish Fini	Dimmable Intensité variable
EDA-BOL	A/CFIX (Bollard Opal PC Lensed Module + Bollard Body Cylinder / Module de bollard à lentille de PC opale + cylindre de boîtier de bollard)	30-24-18W (2400-1920-1440lm)	30-40-50K	120-347V	Black / Noir	D (0-10V)
	B/CFIX (Bollard no Lens Module + Bollard Body Cylinder / Module de bollard sans lentille + cylindre de boîtier de bollard)					
	E/CFIX (Bollard Clear PC Lensed Module + Bollard Body Cylinder / Module de bollard à lentille de PC claire + cylindre de boîtier de bollard)					



LED Area Light Luminaire DEL pour grandes surfaces

SSL-AL3

500~70W 65000~9100lm

Type III is default, type V lens and type IV lens ordered separately
Le type III est par défaut, lentille de type V et lentille de type IV commandées séparément

Slipfitter, Yoke, Trunnion and Pole Mount

Installation sur raccord lisse, étrier, tourillon ou sur fût

cULus listed / Homologué cULus



	Slipfitter Mounting Montage sur raccord lisse		Square / Round Pole Mounting Montage sur fût carré / rond
	Trunnion Mounting Montage sur tourillon		Yoke Mounting Montage sur étrier

Model Modèle	Light Distribution Distribution d'éclairage	Wattage Puissance	CCT / TCP	Voltage Tension	Finish Fini	Dimmable Intensité variable
SSL-AL3	T3 (Type III)	150-100-70W (19500-13000-9100lm) 300-240-200W (39000-31200-26000lm)	30-40-50K	120-347V	Dark Bronze / Bronze foncé Black / Noir White / Blanc	D (0-10V)
		500-450-400W (65000-58500-52000lm)	5000K		Dark Bronze / Bronze foncé Black / Noir	



LED Mini Area Lighter Mini luminaire DEL pour grandes surfaces

SSL-MAL



60~28W



7800~3640lm

Nema Photo Cell for Dusk to Dawn Auto Operation
Cellule photoélectrique NEMA pour une exploitation en mode crépuscule à l'aube

cULus listed / Homologué cULus



90 Degree mounting arm c/w bracket
Bras de montage à 90 degrés avec support

Model Modèle	Wattage Puissance	CCT / TCP	Voltage Tension	Photocell Cellule photoélectrique	Finish Fini
SSL-MAL	60-40-28W (7800-5200-3640lm)	30-40-50K	120-347V	Default / Par défaut	Gray / Gris



LED Mini Flood Mini projecteur DEL

SSL-MFL, SSL-MFL2

New
Nouveau



150~30W



21000~3135lm

Slim & Compact LED Flood Light with Tempered Glass Lens
Projecteur mince et compact avec lentille de verre trempé

Accessories installation of knuckle and trunnion mount
Installation accessoire sur rotule ou tourillon

cULus listed / Homologué cULus



English



Scan for more details

Français



Balayer pour plus de détails

SSL-MFL2



SSL-MFL



Kunckle mount
Montage sur rotule



Trunnion mount
Montage sur tourillon

Model Modèle	Wattage Puissance	CCT / TCP	Voltage Tension	Finish Fini	Installation	Dimmable Intensité variable
SSL-MFL2	60-50-30W (8400-7000-4500lm) 100-80-70W (14000-11200-9800lm) New Nouveau 150-130-120W (21000-18200-16800lm)	30-40-50K	120-347V	Black / Noir	Surface mounting Montage en surface	D (0-10V)
SSL-MFL	30W (3135lm) 50W (5250lm)	30-40-50K	120V	Dark Bronze Bronze foncé	Knuckle mounting Montage sur rotule Trunnion mounting Montage sur tourillon	×



LED Cylinder Cylindre DEL

SSL-ESC, SSL-ESC NEW New
Nouveau

40~10W 4200~1050lm

Ceiling Mtd., pendant Mtd., wall Mtd., and wall Mtd. up / down
Montage sur plafonnier, montage en suspension, montage mural ou
montage mural (haut et bas)

Option of 25° & 60° beam angle / Option d'angles de 25° et 60°

Pre Installed Photocell with 3 wattage selection in SSL-ESC new
version / Cellule photoélectrique avec sélection de 3 puissance avec
la nouvelle version SSL-ESC

cULus listed / Homologué cULus

**IP
65**



LED Security Motion Sensor light Éclairage de sécurité DEL avec détecteur de mouvement

SSL-J5S

20W 2100lm

Motion sensor and photocell sensor
Détecteur de mouvement et cellule photoélectrique

2 @10W adjustable heads and settings

2 têtes réglables de 10W et réglages



Model Modèle	Mounting Montage	Wattage Puissance	CCT / TCP Tension	Beam Angle Angle de faisceau	Dimmable Intensité variable
SSL-ESC	Ceiling Mtd. / Montage sur plafonnier Pendant Mtd. / Montage en suspension Wall Mtd. / Montage mural	20W (2100lm)	30-40-50K 120-347V	45°	D (0-10V)
	Wall Mtd. up & down Montage mural (haut et bas)	40W (4200lm)		45° up / haut 45° down / bas	
SSL-ESC NEW New Nouveau	Ceiling Mtd. / Montage sur plafonnier Pendant Mtd. / Montage en suspension Wall Mtd. / Montage mural	20-15-10W (2400-1800-1200lm)	30-40-50K 120-347V	45°	D (0-10V)
	Wall Mtd. up & down Montage mural (haut et bas)	40 -20 -20 (4800 -2400 -2400 -2400lm)		45° up / haut 45° down / bas	



Model Modèle	Wattage Puissance	CCT / TCP	Voltage Tension	Sensor Décteur	Finish Fin
SSL-J5S	20W (2100lm)	30-40-50K	UNV (120-277V)	Microwave sensor / Décteur à micro-ondes	White / Blanc Black / Noir



LED JamJar Light Luminaire DEL en forme de pot de confiture

SSL-JJA



20~10W



2100~1050lm

Adjustable wall or ceiling Mtd.
Montage mural ou montage au plafond réglable

cULus listed / Homologué cULus

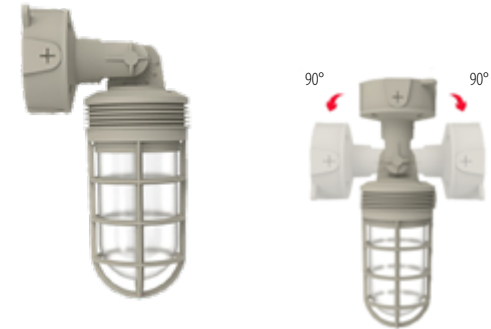

Model Modèle	Wattage Puissance	CCT / TCP	Voltage Tension	Finish Fini
SSL-JJA	20-10W (2100-1050lm)	30-40-50K	120-347V	Grey / Gris



LED Glass Wall Pack Applique murale DEL de verre

SSL-WP1TS



120~30W



15600~3900lm

Glass lens / Lentille de verre
Integral Photocell included / Cellule photoélectrique incluse

cULus listed / Homologué cULus

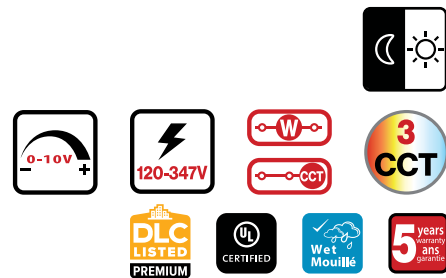

English



Scan for more details

Français



Balayer pour plus de détails



Model Modèle	Wattage Puissance	CCT / TCP	Voltage Tension	Dimmable Intensité variable	Photocell Cellule photoélectrique	Finish Fini
SSL-WP1TS	60-40-30W (7800-5200-3900lm) 120-100-80W (15600-13000-10400lm)	30-40-50K	120-347V	D (0-10V)	PC (Default / Par défaut)	Black / Noir White / Blanc



LED Glass Wall Pack Applique murale DEL de verre

SSL-WP1T, SSL-WP1T+ **New Nouveau**

120~28W 17400~3360lm

Glass lens / Lentille de verre

Efficacy with 145lm/w and built-in photocell with On/Off switch (WP1T+)

Efficacité de 145 lm/w et cellule photoélectrique intégrée avec interrupteur marche/arrêt (WP1T+)

cULus listed / Homologué cULus

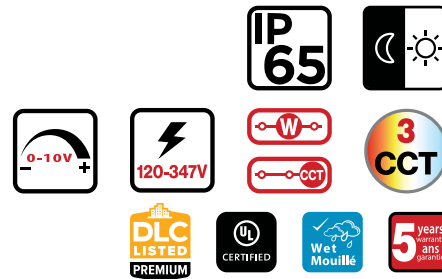

Model Modèle	Wattage Puissance	CCT / TCP	Voltage Tension	Dimmable Intensité variable	Finish Fini	Photocell Cellule photoélectrique
SSL-WP1T+ New Nouveau	60-50-40-30W (8700-7250-5800-4350lm) 120-105-90-75W (17400-15225-13050-10875m)	30-40-50K	120-347V	D (0-10V)	Dark Bronze Bronze foncé Black / Noir	Default / Par défaut
SSL-WP1T	40W (5000lm) 60-40-28W (7200-4800-3360lm) 100-90-80-70W (12000-10800-9600-8400lm) 120-100-75W (15000-12500-9375lm)	30-40-50K	120-347V	D (0-10V)	Dark Bronze Bronze foncé Black / Noir	Optional / En option



LED Adjustable Wall Pack Applique murale DEL réglable

SSL-WP2T, SSL-WP2T+ **New Nouveau**

75~15W 10875~1950lm

Type III light distribution / Distribution de lumière de type III

Motion sensor, photocell, and emergency battery driver Accessories
Détecteur de mouvement, cellule photoélectrique et pilote de batterie de secours accessoires

Efficacy with 145lm/w and built-in photocell (WP2T+)

Efficacité de 145 lm/w et cellule photoélectrique intégrée (WP2T+)

cULus listed / Homologué cULus

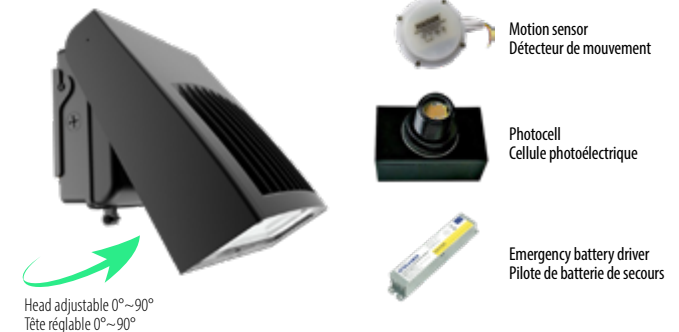
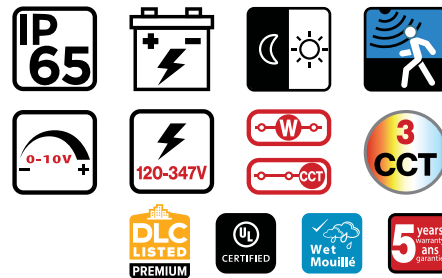

Model Modèle	Wattage Puissance	CCT / TCP	Voltage Tension	Dimmable Intensité variable	Finish Fini	Accessories Accessoires
SSL-WP2T+ New Nouveau	30-24-20-15W (4350-3480-2900-2175lm) 75-60-50-40W (10875-8700-7250-5800lm)	30-40-50K	120-347V	D (0-10V)	Dark Bronze Bronze foncé Black / Noir	Built-in Photocell Cellule photoélectrique intégrée
SSL-WP2T	30-24-20-15W (3900-3120-2600-1950lm) 75-60-50-40W (9750-7800-6500-5200lm)	30-40-50K	120-347V	D (0-10V)	Dark Bronze Bronze foncé	Photocell / Cellule photoélectrique Motion Sensor / Détecteur de mouvement Emergency battery / Batterie de secours



LED Full Cutoff Wall Pack Applique murale DEL à défilement total

SSL-WP3T, SSL-WP3T+ **New Nouveau**

150~25W 18400~3250lm

Photo cell sensor installed
Détecteur à cellule photoélectrique installé

Efficacy with 134lm/w (WP3T+)

Efficacité de 134 lm/w (WP3T+)

cULus listed / Homologué cULus

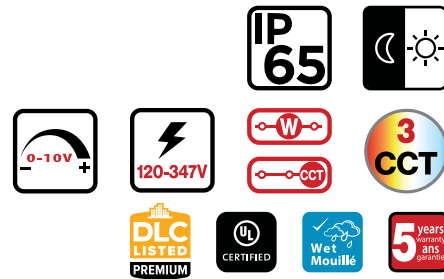

SSL-WP3T+

SSL-WP3T

Model Modèle	Wattage Puissance	CCT / TCP	Voltage Tension	Dimmable Intensité variable	Photo cell Cellule photoélectrique	Finish Fini
SSL-WP3T+ New Nouveau	60-40-25W (8040-5360-3350lm) 120-100-80W (16080-13400-10720lm)	30-40-50K	120-347V	D (0-10V)	Default / Par défaut	Dark bronze / Bronze foncé Black / Noir White / Blanc
SSL-WP3T	60-40-25W (7800-5200-3250lm) 150-120-90W (18400-15600-11700lm)	30-40-50K	120-347V	D (0-10V)	Default / Par défaut	Dark bronze / Bronze foncé Black / Noir



LED Doorway Light Luminaire DEL pour entrée de porte

SSL-DW2, SSL-DW3 **New Nouveau**

30~9W 4200~1260lm

Photo cell sensor installed
Détecteur à cellule photoélectrique installé

Efficacy with 140lm/w (DW3)

Efficacité de 140 lm/w (DW3)

cULus listed / Homologué cULus



SSL-DW3

SSL-DW2

Model Modèle	Wattage Puissance	CCT / TCP	Voltage Tension	Photo cell Cellule photoélectrique	Finish Fini	Dimmable Intensité variable
SSL-DW3 New Nouveau	15-12-9W (2100-1680-1260lm) 30-20-15W (4200-2800-2100lm)	30-40-50K	UNV (120-277V)	Default / Par défaut	Dark bronze Bronze foncé Black / Noir White / Blanc	×
SSL-DW2	15W (1950lm) 30-22-15W (4100-2860-2100lm)	30-40-50K	UNV (120-277V)	Default / Par défaut	Dark bronze Bronze foncé	×



LED Canopy Plafonnier DEL

SSL-CPG



Suitable for J-BOX mounting, and pendant mounting
Convient au montage sur boîte de jonction et au montage suspendu
Installed sensor socket allows for ease of sensor installation
Douille de détecteur installée, facilite l'installation du détecteur
cULus listed / Homologué cULus

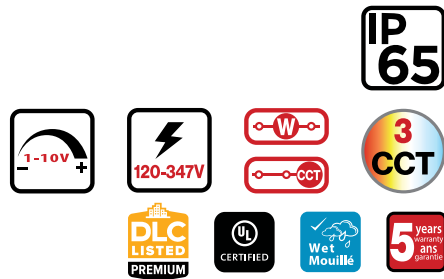

Microwave sensor & remote control
Détecteur à micro-ondes et télécommande

Model Modèle	Wattage Puissance	CCT / TCP	Voltage Tension	Finish Fini	Dimmable Intensité variable	Accessories Accessoires
SSL-CPG	75W (10100lm) 60-40-25W (8100-5130-3110lm) 100-85-75W (14200-12070-10650lm)	30-40-50K	120-347V	White / Blanc	D (1-10V)	Low voltage sensor Détecteur à basse tension



SSL-CP3



Ultra-thin design / Concept ultra mince
PC lens clear / Lentille en polycarbonate incolore
cULus listed / Homologué cULus

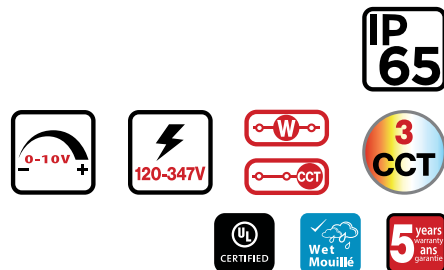

English



Scan for more details

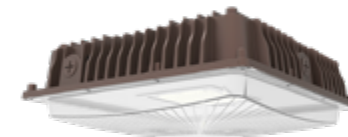

Français



Balayer pour plus de détails

Model Modèle	Wattage Puissance	CCT / TCP	Voltage Tension	Dimmable Intensité variable	Finish Fini	Accessories Accessoires
SSL-CP3	40W (5200lm) 60-40-28W (7800-5200-3640lm)	30-40-50K	120-347V	D (0-10V)	Dark bronze / Bronze foncé	Low voltage sensor Détecteur à basse tension

LED Emergency Sign Enseigne de secours DEL

“Running Man”
«Homme qui court»



Model Modèle	Wattage Puissance	Voltage Tension	Mounting Montage	Remote Capable Capacité à distance	Self Powered Battery Batterie auto alimentée	Image
TL-RMES111 	3W	120/347V	Wall / Mur Ceiling / Plafond Side / Latéral	×	√ (2 hrs / 2 h)	
TL-RMES111-UDC 	2W	120/347V	Wall / Mur Ceiling / Plafond Side / Latéral	√	×	
TL-RMES222 	3W	120/347V	Wall / Mur Ceiling / Plafond Side / Latéral	×	√ (2 hrs / 2 h)	
TL-RMES222-UDC 	2W	120/347V	Wall / Mur Ceiling / Plafond Side / Latéral	√	×	
TL-RMES301 	3W (120V) 4W (347V)	120/347V	Wall / Mur Ceiling / Plafond Side / Latéral	×	√ (2 hrs / 2 h)	
TL-RMES301-UDC 	3W (120V) 4W (347V)	120/347V	Wall / Mur Ceiling / Plafond Side / Latéral	√	×	
TL-RMES333 (6500K) 	3W	120/347V	Wall / Mur Side / Latéral	×	√ (2 hrs / 2 h)	
TL-RMES302-5W (6500K) 	34W (5W×2 lamps / lampes)	120/347V	Wall / Mur	√	√ (0.5 hrs / 0,5 h)	
TL-RMES-11-WL (6500K) 	4.2W	120/347V	Wall / Mur Ceiling / Plafond Side / Latéral	×	√ (2 hrs / 2 h)	

LED Emergency Light Éclairage DEL de secours

Remote head
Tête à distance



Model Modèle	Wattage Puissance	Voltage Tension	CCT / TCP	Mounting Montage	Remote Capable Capacité à distance	Self Powered Battery Batterie auto alimentée	Image
TL-EM001 	4W	120/347V	7000K	Wall / Mur Ceiling / Plafond	×	√ (1.5 hrs / 1,5 h)	
TL-EM002-4W 	4W	5-12 VDC / VCC	6500K	Wall / Mur Ceiling / Plafond	√	×	
TL-EM002-10W 	10W	5-12 VDC / VCC	6500K	Wall / Mur Ceiling / Plafond	√	×	
TL-EM002-14W 	14W	5-12 VDC / VCC	6500K	Wall / Mur Ceiling / Plafond	√	×	
TL-EM003-2W 	2W	5-12 VDC / VCC	6500K	Wall / Mur Ceiling / Plafond	√	×	
TL-EM003-5W 	5W	5-12 VDC / VCC	6500K	Wall / Mur Ceiling / Plafond	√	×	
TL-EM003-7W 	7W	5-12 VDC / VCC	6500K	Wall / Mur Ceiling / Plafond	√	×	

With battery
Avec batterie







Model Modèle	Wattage Puissance	Voltage Tension	CCT TCP	Mounting Montage	Remote Capable Capacité à distance	Self Powered Battery Batterie auto alimentée
TL-EMRM/24W/6VDC /120-347V 	4W (24W for remotes / 24W pour télécommandes)	120/347V	7000K	Wall / Mur Ceiling / Plafond	√	√ (0.5 hrs / 0,5 h)

Metal Battery Pack Bloc-batterie de métal

Steel housing
Boîtier d'acier



Model Modèle	Wattage Puissance	Voltage Tension	LED Heads Phares DEL	Mounting Montage	Remote Capable Capacité à distance	Self Powered Battery Batterie auto alimentée
TL-EMRM/34W/6VDC /2-5W/120-347V	34W	120/347V	5W×2	Wall / Mur	√ 6V, 24W	√ (0.5 hrs / 0,5 h)
						
TL-EMRM/95W/12VDC /2-5W/120-347V	95W	120/347V	5W×2	Wall / Mur	√ 12V, 85W	√ (0.5 hrs / 0,5 h)
						
TL-EMRM/140W/12VDC /2-5W/120-347V	140W	120/347V	5W×2	Wall / Mur	√ 12V, 130W	√ (0.5 hrs / 0,5 h)
						
TL-EMRM/275W/12VDC /2-5W/120-347V	275W	120/347V	5W×2	Wall / Mur	√ 123V, 265W	√ (0.5 hrs / 0,5 h)
						

Motion Sensor Détecteur de mouvement

TL-2052, TL-1032, TL-8012, TL-6012



Model Modèle	Voltage Tension	Coverage Couverture
TL-1032 PIR ceiling mount occupancy sensor Détecteur de présence à infrarouge passif pour montage au plafond	120-277V	360°
TL-2052 PIR high bay mount occupancy sensor Détecteur de présence à infrarouge passif à montage à très grande hauteur	120-277 / 347V	360°
TL-8012 (Neutral required / Neutre requis) PIR wall switch occupancy sensor Interrupteur mural avec détecteur de présence à infrarouge passif	120-277V	180°
TL-6012 (No Neutral required / Aucun neutre requis) PIR wall switch occupancy sensor Interrupteur mural avec détecteur de présence à infrarouge passif	120-277V	180°



TL-1032



TL-2052



TL-8012, TL-6012



Motion Sensor Détecteur de mouvement

TL-HB/Sensor/Microwave

TL-HB/Sensor/PIR

TL-HB/Sensor/Controller

coming soon
à venir



TL-HB/Sensor/Microwave



TL-HB/Sensor/PIR



TL-HB/Sensor/Controller

cULus listed / Homologué cULus

Model Modèle	Voltage Tension	Compatible Model Modèle compatible
TL-HB/Sensor/Microwave HighBay 12V Microwave Plug In Sensor 3.5mm, 0-10V dimming Détecteur enfilable 12V 3,5 mm, gradation 0-10V pour luminaire pour très grande hauteur	12V	SSL-LHB5, SSL-CHB2
TL-HB/Sensor/PIR HighBay 12V DC PIR Plug In Sensor 3.5mm Détecteur enfilable à infrarouge passif 12V CC 3,5 mm pour luminaire pour très grande hauteur	12V	SSL-LHB5, SSL-CHB2
TL-HB/Sensor/Controller HighBay Sensor Controller Contrôleur détecteur pour luminaire pour très grande hauteur	-	SSL-LHB5, SSL-CHB2



Smart Sensor Détecteur intelligent

TL-Smart/Sensor/BLE

coming soon
à venir

Compatible with
Compatible avec

High Bay / Luminaire pour très grande hauteur
Back-lit Panel / Panneau à rétroéclairage
Centre Basket / Luminaire à panier central
Strips / Réglettes
Vapor Tight / Luminaire étanche à la vapeur
Downlight / Encastré
Wrap Around / Luminaire enveloppant

cULus listed / Homologué cULus

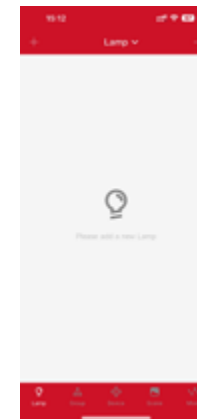

Daylight Harvesting
Utilisation de la lumière du jour



Adjustable Sensitivity
Sensibilité réglable



Scene Selection
Sélection de scène



Automated Control
Contrôle automatisé

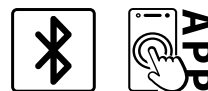



5CCT LED Lamps Ampoules DEL 5TCP

**New
Nouveau**

HD-A19/5CCT, HD-BR30/5CCT, HD-PAR/5CCT

5CCT Selectable (27/30/35/40/50K)
5TCP sélectionnables (27/30/35/40/50K)

High CRI (90+)
IRC élevé (90+)

Model Modèle	Wattage Puissance	CCT / TCP	Base Culot	Dimmable Intensité variable	Enclosed Fixture Luminaire fermé
HD-A19/190/5CCT	15~6W (1600~450lm)	27-30-35-40-50K	E26	✓	✓
HD-A19/5CCT/GU (CRI 80)	9W (800lm)	3000K	GU24	✓	✓
HD-BR30/190/5CCT	8.5W (650lm)	27-30-35-40-50K	E26	✓	✓



Model Modèle	Wattage Puissance	CCT / TCP	Beam Angle Angle de faisceau	Dimmable Intensité variable	Finish Fini	Enclosed Fixture Luminaire fermé
HD-PAR38/190/5CCT	16W (1400lm)	27-30-35-40-50K	WFL40 (40°)	✓	White / Blanc Black / Noir	×
HD-PAR30LN/190/5CCT (Long neck / Long cou)	12W (840lm)	27-30-35-40-50K	WFL40 (40°)	✓	White / Blanc Black / Noir	×
HD-PAR20/190/5CCT	7W (500lm)	27-30-35-40-50K	WFL40 (40°)	✓	White / Blanc Black / Noir	×

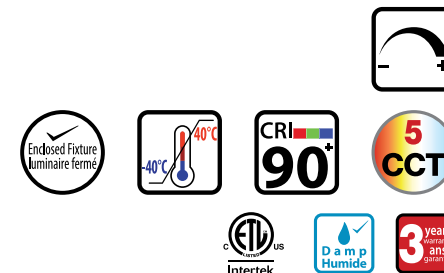



LED DIM To Warm DEL à gradation vers le chaud

PAR20

Dimming from 3000K up to 2200K
Gradation de 3 000K à 2 200K



Model Modèle	Wattage Puissance	CCT / TCP	Base Culot	Dimmable Intensité variable
VIV-PAR20/DTW	6.5W (500lm)	3000-2200K	E26	DTW (Dim to warm / Gradation vers le chaud)



LED High Lumen DEL à flux lumineux élevé

PS25, PS30, A21

High lumen
Flux lumineux élevé



Model Modèle	Wattage Puissance	CCT / TCP	Base Culot	Dimmable Intensité variable
VIV-PS25	27W (3200lm)	4000K	E26	×
VIV-PS30	36W (5000lm)	4000K	EX39	×
VIV-A21/X22 (ES ×)	20W (2300lm)	3000K	E26	×
VIV-A21/3WAY	15-10-5W (1600-1100-600lm)	2700K	E26	√





LED A Shape Lamp Ampoules DEL en forme de A

A19, A15

Enclosed fixture application
Utilisation dans un luminaire fermé

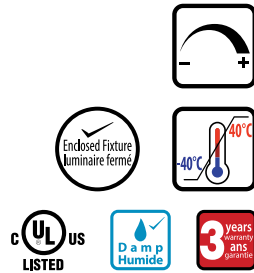

Model Modèle	Wattage Puissance	CCT / TCP	Base Culot	Dimmable Intensité variable
VIV-A15	5.5W (450lm)	2700K, 3000K, 4000K	E26	✓
VIV-A19/X18	15/9W (1600/800lm)	3000K	E26	✓
PV-A19/S2	9W (800lm) 15/8.5W (1600/800lm)	4000K 2700K, 3000K, 4000K, 5000K	E26	✓ ×
PV-A19/S1	8.5W (800lm)	2700K	E26	×
PV-A19/I8	14W (1600lm)	3000K	E26	×



LED G9, G4 & MR11 Ampoules G9, G4 et MR11 DEL

G9, G4, MR11

Enclosed fixture application
Utilisation dans un luminaire fermé



Model Modèle	Wattage Puissance	CCT / TCP	Base Culot	Enclosed Fixture Luminaire fermé	Dimmable Intensité variable
VIV-G9	4W (450lm)	2700K, 3000K, 4000K	G9	✓	✓
VIV-G4 (12V)	2.5W (300lm)	3000K, 4000K	G4	×	✓
VASO-MR11 (12V, Glass housing / Boîtier de verre)	3W (200lm)	3000K	GU4	✓	×



LED MR16 Lamp Lampe MR16 DEL

VIV-MR16, PRO-MR16

Cost-effective
Rentable



Model Modèle	Wattage Puissance	CCT / TCP	Beam Angle Angle de faisceau	Base Culot	Neck Length (JDR) Longueur du cou	Dimmable Intensité variable
VIV-MR16/X23	6.5W (500lm)	2700K, 3000K, 4000K	25°, 35°, 40°	GU5.3 (12V), GU10	-	✓
	6W (500 / 480lm)	2700K, 3000K, 4000K, 5000K	25°, 40°	JDR (E26)	Long, Short / Long, court	✓
VIV-MR16	6.5W (500lm)	2700K, 4000K	25°, 35°	JDR (E26)	Short / Court	✓



VASO-MR16

Glass housing
Boîtier de verre



Model Modèle	Wattage Puissance	CCT / TCP	Beam Angle Angle de faisceau	Base Culot	Dimmable Intensité variable
VASO-MR16	5W (500lm)	3000K, 4000K	WFL40 (40°)	GU10	✓
	6W (450lm)	3000K	FL35 (35°)	GU5.3 (12V)	✓



LED PAR Lamp Lampe PAR DEL

HD-PAR38, PAR30, PAR20

High lumen
Flux lumineux élevé

Grey metal housing
Boîtier de métal gris

Easy retrofit
Rénovation facile

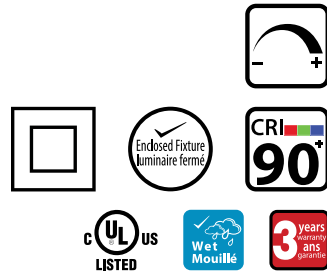

Model Modèle	Wattage Puissance	CCT / TCP	Beam Angle Angle de faisceau	Dimmable Intensité variable
HD-PAR38	27W (3000lm) 26W (2400lm) 38W (4000lm)	4000K 3000K 3000K	WFL40 (40°)	√ ×(38W)
HD-PAR30LN (Long neck / Long cou)	20W (2300lm)	3000K	FL25 (25°)	√

VASO-PAR38

Glass housing + PC lens
Boîtier de verre et lentille de polycarbonate



Model Modèle	Wattage Puissance	CCT / TCP	Beam Angle Angle de faisceau	Dimmable Intensité variable
VASO-PAR38	15W (1300lm)	3000K 4000K	WFL40 (40°)	√



LED Filament A15 Lamp Lampe A15 DEL à filament

AR2-A15/I90 **New Nouveau** **CRI 90+**

AR-A15LNVF **Low Flicker**
Clignotement faible



Model Modèle	Wattage Puissance	CCT / TCP	Dimmable Intensité variable	Cover Gaine
AR2-A15/I90 New Nouveau	5.5W (500lm)	3000K	✓	Milky White / Blanc laiteux
AR-A15LNVF (CRI 80)	5W (500lm)	3000K	✓	Clear / Incolore



LED Filament A19 Lamp Lampe A19 DEL à filament

AR2-A19/I90 **New Nouveau** **CRI 90+**

AR-A19LNVF **Low Flicker**
Clignotement faible



Model Modèle	Wattage Puissance	CCT / TCP	Dimmable Intensité variable	Cover Gaine
AR2-A19/I90 New Nouveau	9W (810lm)	2700K 3000K	✓	Clear / Incolore Milky White / Blanc laiteux
AR-A19LNVF (CRI 80)	8W (800lm)	3000K 4000K	✓	Clear / Incolore Milky White / Blanc laiteux



LED Filament ST19 Lamp Lampe ST19 DEL à filament

AR2-ST19/I90 **New Nouveau**



Model Modèle	Wattage Puissance	CCT / TCP	Dimmable Intensité variable	Cover Gaine	Output Flux lumineux
AR2-ST19/I90 New Nouveau	5.5W (600lm)	3000K 4000K	✓	Clear / Incolore	High lumen output Flux lumineux élevé



LED Filament B10 Lamp Lampe B10 DEL à filament

AR2-B10/I90 **New Nouveau**



AR-B10LNVF **Low Flicker**
Clignotement faible



Model Modèle	Wattage Puissance	CCT / TCP	Base Culot	Dimmable Intensité variable	Cover Gaine
AR2-B10/I90 New Nouveau	5.5W (500lm / 450lm)	2200K 3000K 4000K	E12	✓	Amber / Ambre (450lm) Clear / Incolore
AR-B10LNVF (CRI 80)	5W (500lm)	2700K	E12 E26	✓	Clear / Incolore



LED Filament Globe Lamp Lampe globe DEL à filament

AR2-G16.5/I90  

AR-G16.5LF
AR-G30LF
AR-G30LNVF
AR-G40LF 



G30



G16.5



G40



Model Modèle	Wattage Puissance	CCT / TCP	Base Culot	Dimmable Intensité variable	Cover Gaine
AR2-G16.5/I90 <small>New Nouveau</small> (CRI 80)	5.5W (500lm) 5W (500lm)	3000K	E12	✓	Clear / Incolore
AR-G16.5LF (CRI 80)	4W (300lm) 5W (500lm)	3000K 2700K	E12	✓	Milky White / Blanc laiteux (4W) Clear / Incolore (5W)
AR-G30LNVF (CRI 80)	5W (500lm / 450lm)	3000K	E26	✓	Milky White / Blanc laiteux (450lm) Clear / Incolore
AR-G30LF (CRI 80)	5W (500lm / 450lm)	2200K, 2700K, 3000K	E26	✓	Amber / Ambre (450lm) Clear / Incolore
AR-G40LF (CRI 80)	4W (350lm / 320lm) 5W (450lm)	3000K 2200K	E26	✓	Milky White / Blanc laiteux (320lm) Clear / Incolore Amber / Ambre (5W)



LED Filament Lamp Lampe DEL à filament

AR2-T6/I90
AR2-T14/I90

New
Nouveau



AR-ST12LNVF
AR-T9LNVF
AR-T9LF



AR-S14



T6



T14



T9



ST12



S14

Model Modèle	Wattage Puissance	CCT / TCP	Base Culot	Dimmable Intensité variable	Cover Gaine
AR2-T6/I90 <small>New Nouveau</small>	5.5W (500lm)	3000K	E12	✓	Clear / Incolore
AR2-T14/I90 <small>New Nouveau</small>	5.5W (500lm)	3000K	E26	✓	Clear / Incolore
AR-ST12LNVF	4.5W (500lm)	3000K	E12	✓	Clear / Incolore
AR-T9LNVF	5W (500lm / 450lm)	2200K 2700K 3000K	E26	✓	Clear / Incolore Amber / Ambre (450lm)
AR-T9LF	4W (350lm)	3000K	E26	✓	Clear / Incolore
AR-S14	1W (75lm)	2200K 5000K	E26	×	Clear / Incolore





LED T5 (Selectable CCT) T5 DEL (TCP sélectionnables)

HD-T5DFSP/3CCT **New**
Nouveau

Direct Fit
Remplacement direct

T5 HO&HE fluorescent replacement
Remplacement de T5 HO et HE fluorescents

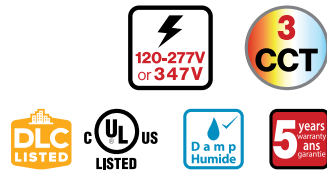

Model Modèle	Size Taille	Wattage Puissance	CCT / TCP	Frost Givré	Voltage Tension
HD-T5DFSP/3CCT (HE)	2'	2' (6W, 950lm)	35-40-50K	Frost / Givré	120-277V, 347V
	3'	3' (9W, 1300lm)			
	4'	4' (13W, 1950lm)			
HD-T5DFSP/3CCT (HO)	2'	2' (9W, 1300lm)	35-40-50K	Frost / Givré	120-277V, 347V
	3'	3' (18W, 2200lm)			
	4'	4' (25W, 3500lm)			

HD-T5BPSP/5CCT **New**
Nouveau

Ballast Bypass
Dérivation du ballast

T5 HO&HE fluorescent replacement
Remplacement de T5 HO et HE fluorescents

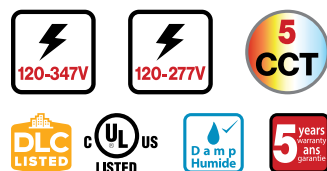

Model Modèle	Size Taille	Wattage Puissance	CCT / TCP	Frost Givré	Voltage Tension
HD-T5BPSP/3CCT (HE)	4'	4' (13W, 1700lm)	30-35-40-50-65K	Frost / Givré	120-277V
HD-T5BPSP/3CCT (HO)	2'	2' (12W, 1500lm)	30-35-40-50-65K	Frost / Givré	120-277V
	3'	3' (16W, 2000lm)			120-347V (4' HO)
	4'	4' (25W, 3300lm)			



LED T5 Tube Tube T5 DEL

Direct Fit / Remplacement direct

T5 HO&HE fluorescent replacement
Remplacement de T5 HO et HE fluorescents

No rewiring required
Pas de recâblage nécessaire

T5DFSP4

Plastic end caps, glass tube with PET film, shatterprotect
Embouts de plastique, tube de verre avec film PET, protection contre les impacts



T5DF4

All glass construction, aluminium end caps
Construction toute en verre, embouts d'aluminium



Model Modèle	Size Taille	Wattage Puissance	CCT / TCP	Frost Givré	Voltage Tension
VIV-T5DFSP4 (HO)	2'	2' (9W, 1000lm)	3000K, 3500K	Frost / Givré	120-277V, 347V
	3'	3' (18W, 1700lm)	4000K, 5000K		
	4' (DLC √)	4' (22.5W, 3300lm)			
VIV-T5DFSP4 (HE)	3'	3' (9W, 1300lm)	3000K, 3500K	Frost / Givré	120-277V, 347V
	4' (DLC √)	4' (13W, 1900lm)	4000K, 5000K		
VIV-T5DF4 (HO)	4' (DLC √)	4' (25W, 3600lm)	3000K, 3500K 4000K, 5000K	Frost / Givré	120-277V, 347V

Ballast Bypass / Dérivation du ballast

T5 HO&HE fluorescent replacement
Remplacement de T5 HO et HE fluorescents

External ballast not required
Ballast externe non requis



Model Modèle	Size Taille	Wattage Puissance	CCT / TCP	Frost Givré	Voltage Tension
VIV-T5BSP4(HO)	2'	2' (12W, 1450lm)	4000K	Frost / Givré	120-277V
VIV-T5BSP4(HE)	4'	4' (13W, 1650lm)	4000K	Frost / Givré	120-277V





LED T8 Tube Selectable CCT, Selectable Wattage

Tube T8 DEL TCP sélectionnables, puissances sélectionnables

Model Modèle	Type	Size Taille	Wattage Puissance	CCT / TCP	Voltage Tension	Base Culot	Frost Givré
HD-T8HYSP	Hybrid / Hybride	2' 3'	2' (9W,1450lm) 3' (11W,1700lm)	30-35-40-50-65K	120-347V	G13	Frost / Givré
HD-T8HYSP/U6 (DLC ×)	Hybrid / Hybride (U6-U Bend / U6 plié en U)	2'	13W (1800lm)	30-35-40-50-65K	120-277V	G13	Frost / Givré
HD-T8HYSP/N	Hybrid / Hybride (Nano)	4'	13W (2200lm)	30-35-40-50-65K	120-347V	G13	Frost / Givré
HD-T8BPSP	Ballast Bypass Dérivation du ballast	4'	4' (16-14-11.5W,2400-2200-1800lm)	30-35-40-50-65K	120-347V	G13	Frost / Givré
		8'	8' (38W,5500lm)	40-50-65K		Fa8 R17d	
HD-T8DFSP	Direct Fit Ajustement direct	4'	4' (10W,1800lm) 4' (13W,2200lm)	30-35-40-50-65K	120-347V	G13	Frost / Givré



4', G13



8', Fa8



8', R17d



2', U6





LED T8 Tube Tube T8 DEL

Direct Fit / Remplacement direct

T8 fluorescent replacement
Remplacement de T8 fluorescent

No rewiring required
Pas de recâblage nécessaire



Ballast Bypass / Dérivation du ballast

T8 fluorescent replacement
Remplacement de T8 fluorescent

External ballast not required
Ballast externe non requis



T8DF4

All glass construction, aluminium end caps
Construction toute en verre, embouts d'aluminium



T8DFSP4

Plastic end caps, glass tube with PET film, shatterprotect
Embouts de plastique, tube de verre avec film PET, protection contre les impacts



Single pin base, 8 ft
Culot à une broche, longueur de 8 pieds

Model Modèle	Size Taille	Wattage Puissance	CCT / TCP	Frost Givré
VIV-T8DFSP4	46" (DLC x)	46" (15W, 2000lm)	4000K, 5000K	Frost / Givré
VIV-T8DFSP4 (Single pin base / Culot à une broche)	8' (DLC x)	8' (24W, 3500lm)	3000K, 3500K, 4000K, 5000K	Frost / Givré
VIV-T8DF4	3'	3' (11W, 1650lm)	3000K, 4000K	Frost / Givré
	4'	4' (11.5W, 1830lm)	4000K, 5000K	

T8BP7

Plastic end caps, glass tube
Embouts de plastique, tube de verre



T8BPSP4

Plastic end caps, glass tube with PET film, shatterprotect
Embouts de plastique, tube de verre avec film PET, protection contre les impacts



R17d base, 8 ft
Culot : R17d, 8 pi

Model Modèle	Size Taille	Wattage Puissance	Voltage Tension	CCT / TCP	Frost Givré
VIV-T8BP7	4'	4' (12W, 1800lm) 4' (15W, 2200lm)	120-277V	4000K, 5000K	Frost / Givré
VIV-T8BPSP4	4'	4' (10.5W, 1700lm)	120-277V	4000K	Frost / Givré
	8' (R17d, DLC x)	8' (42W, 5500lm)	120-347V	5000K	
VIV-T8BPSP4 (347V)	4'	4' (15W, 2200lm)	347V	4000K	Frost / Givré
	8' (R17d, DLC x)	8' (42W, 5500lm)		5000K	



LED T8 Tube Tube T8 DEL

Ballast Bypass / Dérivation du ballast

Full spectrum / Spectre complet



R9 >90, CRI>95



Model Modèle	Size Taille	Wattage Puissance	Voltage Tension	CCT / TCP	Frost Givré
VIV-T8BPSP/195	4'	4' (18.5W, 2100lm)	120-347V	5700K	Frost / Givré



Ballast Bypass / Dérivation du ballast

Flicker free / Sans clignotement



Model Modèle	Size Taille	Wattage Puissance	Voltage Tension	CCT / TCP	Frost Givré
VIV-T8BPSP4/FF	4'	4' (10.5W, 1700lm)	120-277V	4000K	Frost / Givré





LED T8 Tube Tube T8 DEL

Ballast Bypass / Dérivation du ballast

Nano sign light
Panneau lumineux Nano

T8HO / T12HO fluorescent replacement
Remplacement de T8HO ou T12HO fluorescents

Double sided LED strip
Concept de réglette DEL à deux extrémités

Beam angle 330°
Angle de faisceau 330°



Rotatable nano tube / Tube nano rotatif

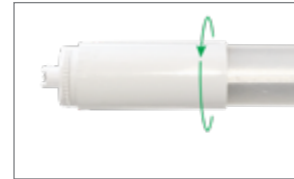

Switchable end caps / Embouts commutables

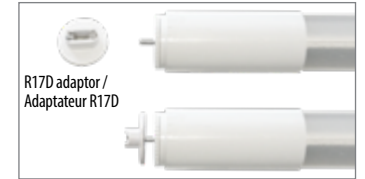

Model Modèle	Size Taille	Wattage Puissance	Voltage Tension	CCT / TCP	Frost Givré
VIV-T8BPSP/N/DS	2', 3', 4' 5', 6', 7' 8', 9', 10'	2' (9W, 1250lm), 3' (12W, 1650lm), 4' (18W, 2500lm) 5' (24W, 3350lm), 6' (30W, 4200lm), 7' (32W, 4500lm) 8' (36W, 5000lm), 9' (42W, 5800lm), 10' (48W, 6700lm)	120-277V	6500K	Frost / Givré



LED T8 Tube Tube T8 DEL

Ballast Bypass / Dérivation du ballast

Nano-freezer / cooler
Congélateur Nano / chambre froide

Humidity tolerance 95%
Tolérance à l'humidité 95%

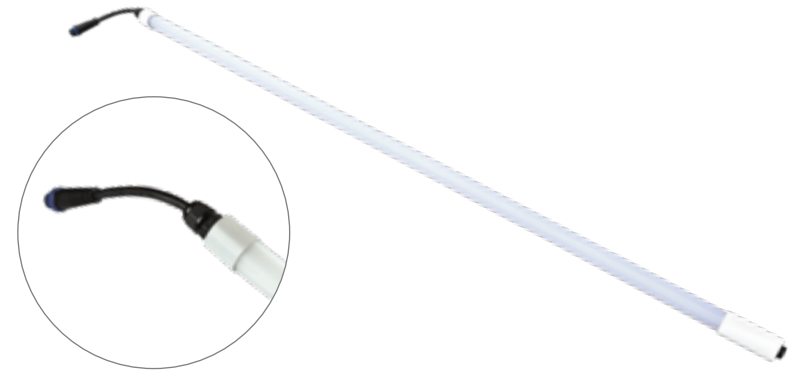

Model Modèle	Size Taille	Wattage Puissance	Voltage Tension	CCT / TCP	Wiring Câblage
VIV-T8BPSP/N/FC	4' 5' 6'	4' (18W, 2250lm) 5' (22W, 2750lm) 6' (26W, 3250lm)	120-277V	4000K	Plugs directly into AC outlet / Se branche directement dans une prise c.a.



LED T8 Tube Tube T8 DEL

Ballast Bypass / Dérivation du ballast

Blacklight / lumière noire



Model Modèle	Size Taille	Wattage Puissance	Voltage Tension	Peak wave length (nm) Longueur d'onde maximale	UVA OUT / SORTIE DES UVA (1m) (µw/cm ²)	Wiring Câblage
VIV-T8BPBL	4'	11.5W	120-347V	365	33	Single & Double Ended simple et double embout



T8 Electronic Ballast Ballast électronique T8

TL Series / Série TL

Instant Start, UNV & 347V
Démarriage instantané, UNV et 347V



Model Modèle	Voltage Tension	No. of Lamps Qté de lampe	Lamp Type Type de lampe
TL-232UNV-IS	UNV (120-277V)	2	F32T8
TL-432UNV-IS	UNV (120-277V)	4	F32T8
TL-232347-IS	347V	2	F32T8
TL-432347-IS	347V	4	F32T8





LED PL PL DEL

Ballast Bypass / Dérivation du ballast

3 CCT Selectable / 3 TCP sélectionnables

Replace 4 pin G24q and GX24q CFL

Remplace une AFC G24q et GX24q à 4 broches

Direct Fit / Remplacement direct

Replace 4 pin G24q and GX24q CFL

Remplace une AFC G24q et GX24q à 4 broches



VIV-PL/BP/3CCT/H

Vertical
Verticale



Vertical Long
Verticale longue



Horizontal
Horizontale



VIV-PL/DF

Model Modèle	Connect Connexion	Wattage Puissance	CCT / TCP	Shape Forme
VIV-PL/BP/3CCT/H	Ballast Bypass / Dérivation du ballast	8W (950lm)	30-40-50K	Horizontal / Horizontale
VIV-PL/DF/H	Direct Fit / Remplacement direct	9W (1050lm)	2700K, 3000K, 3500K, 4000K	Horizontal / Horizontale
VIV-PL/DF/V	Direct Fit / Remplacement direct	9W (1050lm)	3500K, 5000K	Vertical / Verticale
VIV-PL/DF/VL	Direct Fit / Remplacement direct	9W (1050lm)	2700K, 3000K, 3500K, 4000K, 5000K	Vertical long / Verticale longue



LED PLL Lamp Lampe PLL DEL

Direct Fit & Bypass
Remplacement direct et dérivation

Replace 4 pin 2G11 CFL

Remplace une AFC 2G11 à 4 broches



Model Modèle	Connect Connexion	Wattage Puissance	CCT / TCP	Size Taille
VIV-PLL/DF	Direct Fit / Remplacement direct	15W (1600lm) 19W (2000lm)	2700K, 3000K, 3500K, 4000K	21"
VIV-PLL/BP	Ballast Bypass / Dérivation du ballast	15W (1200lm) 18W (1500lm)	2700K, 3000K, 3500K, 4000K	16" (15W) 21" (18W)



LED Stringer Light Set Ensemble de guirlande de lumières DEL

SSL-STRINGER

Decorative RGB & White / White
Ampoules décoratives RVB et blanches / blanches



Model Modèle	Total Length Longueur totale	Wattage Per Set Puissance par jeu	CCT / TCP	Dimmable Accessories Accessoires intensité variable	Voltage Tension
SSL-STRINGER	48'	24W (1 bulb / ampoule 1W)	2200K	×	120V
SSL-STRINGER (RGBW)	48'	4.8W (1 bulb / ampoule 0.2W)	RGBW (Red,Green,Blue,White 2200K / Rouge, vert, bleu, blanc 2.200K)	√	120V







Upcoming Products Produits à venir

Coming Soon Offerts bientôt	Product Produit	Key Features Principales caractéristiques	Wattage Puissance	Voltage Tension	CCT / TCP	CRI / IRC	Dimmable Intensité variable	Option	Product Image Image du produit
Q4, 2024	Centre Basket Panier central	Square Single Piece Lens Lentille une pièce carrée 100%-1% Dim / Gradation 100%-1% 1'x4', 2'x2', 2'x4'	40-56W (5000-7000lm)	120-347V	35-40-50K	80 / 90	0-10V Dim 1%	PIR/MS/BT Sensor Décteur infrarouge passif/MS/BT Emergency Driver Pilote de secours Human Centric Humanocentrique	
Q4, 2024	4'&8' LED Strips / Réglettes DEL	High Lumen / Flux lumineux élevé 4' @ 10,000+Lm 8' @ 20,000+Lm	65-30W, 4' 150-75W, 8'	120-347V	35-40-50K	80	0-10V Dim	PIR/MS/BT Sensor Décteur infrarouge passif/MS/BT Emergency Driver Pilote de secours Asymmetrical Reflectors Réflecteurs asymétriques	
Q4, 2024	Surface Mount Frames Cadres de montage en surface	4" x 48" to / à 12" x 48" 4" x 24", 12" x 24"	20-40W 22W	120-277V 120V	27-30-35-40-50K	80	120-277V, 0-10V Dim 120V, Triac Dim	-	
Q4, 2024	Commercial Downlight Encastré commercial (RGD-CDR/A)	With 12V AUX / Avec aux. 12V 4" & 6" 	4" @ 8-7-6W (800-700-600lm) 6" @ 23-18-10W (2300-1800-1000lm)	120-347V	27-30-35-40-50K	90	0-10V Dim	MS Sensor Décteur MS 	



Upcoming Products Produits à venir

Coming Soon Offerts bientôt	Product Produit	Key Features Principales caractéristiques	Wattage Puissance	Voltage Tension	CCT / TCP	CRI / IRC	Dimmable Intensité variable	Option	Product Image Image du produit
Q4, 2024	Regressed Gimbal Downlight Encastré à cardan en retrait (RGD-ECL/4/DTW)	Dim to Warm / Gradation vers le chaud 4" FT6 cable / câble	12W (900lm)	120V	DTW 30K-18K	90	Triac	-	
Q4, 2024	Downlight / Encastré (RGD-SMT2)	1" & 2" Exchangeable trims (round/square, white/black) Garnitures échangeables (ronde/carrée, blanche/noire)	1" @ 7-5-3W (500-350-150lm) 6" @ 15-12-8W (1000-800-600lm)	120V	27-30-35-40-50K	90	Triac	-	
Q4, 2024	Flush Mount / Montage affleurant (RGD-FM2/2R)	Slimmer Double Ring Anneau double mince 12", 14" & 16" Built-in Sensor Détecteur intégré 14" & 16"	12" @ 22-18-15W (1540-1260-1000lm) 14" @ 24-21-18W (1800-1575-1350lm) 16" @ 24-21-18W (2350-2000-1760lm)	120V	27-30-35-40-50K	90	Triac	-	
Q4, 2024	Flush Mount / Montage affleurant (RGD-FM2/PC)	Slim modern PC lens design Concept lentille PC mince moderne Beautiful lighting distribution Belle distribution de lumière 11", 13" & 15"	11" @ 16-14-12W (1200-1050-900lm) 13" @ 22-18-15W (1650-1350-1156lm) 15" @ 24-21-18W (1800-1600-1350lm)	120V	27-30-35-40-50K	90	Triac	-	

Better light, better life.
Meilleure lumière, meilleure vie.



 www.turolight.com

 sales@turolight.com

 905-479-7093, 1-888-425-7093

 2751 John Street Markham, ON L3R 2Y8



V 2 4 - 0 1